



Smart 
Condition

www.smartcondition.mx

contacto@smartcondition.mx

 (493) 114 1974

 (493) 115 7255

 (614) 196 6239

NEST INDUSTRY 4.0

All In One Predictive Maintenance Solution



acoem

CREATING ENVIRONMENTS OF POSSIBILITY

Nest Industry 4.0

Predictive Maintenance Solution

Maintenance and reliability professionals today have adopted modern online condition monitoring and protection technologies for monitoring critical machinery assets. A connected and fully-integrated plant-wide condition monitoring system offers a holistic view of the entire plant, enabling powerful predictive analytics. The unparalleled amount of data collected by such a system empowers reliability managers and proactive maintenance teams to make smarter decisions. NESTi4.0 is the next evolution in predictive maintenance strategy, helping the transition to agile and accurate real-time condition monitoring of an entire industrial facility.

NESTi4.0 Software Platform provides clear, concise and easy to understand information, for everyone involved in maintaining industrial machinery in operational conditions. NESTi4.0 is the most productive vibration analysis software available in the market. In addition to the full range of conventional analysis tools, the user is literally guided through his analysis with the help of a set of innovative tools, like: intuitive machine setup, guided analysis, and ease of access to the automated reports.

Embrace the future of condition monitoring with NESTi4.0 and its revolutionary artificial intelligence to support predictive maintenance in your digital factory.

The only predictive maintenance and diagnostic tool you will ever need

Easy Access To Big Data

Intuitive Machine Builder

Guided Analysis

Automatic Reporting

Shock Finder™ Index



- Easy shock identification and diagnostic
- Qualifies shocks automatically in the time waveform

Bearing Defect™ Factor

- Evaluates the roller/ball bearing health automatically
- Continuously grows during the bearing life cycle
- Early fault detection



Accurex™

Automatic machinery diagnostics

- The color of the machine (Green, Yellow, Red) corresponds to the first level diagnostic and shows the urgency of the analysis
- Results of faults identified are pre-filled and can be modified by the user



HarmoniX™ Index

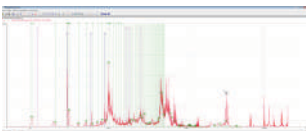

- Full frequency highresolution merged spectrum
- Quantifies harmonic families in spectra automatically

Open Data Platform

- Easily connect your asset's health information to your ecosystem
- Automatically publish all measurements and diagnostics results available from the matrix
 - Standard OPC UA and CSV export formats

Nest i4.0 Integrates Your Entire Monitoring Program

- **Fast visual insight:** A view into potential machinery health issues
- **Secure worldwide access:** Insight into your program's data set
- **Software augmented diagnostic and predictive analysis:** AI powered and based on ACOEM's 50+ years of expertise in predictive maintenance technology
- **Wireless monitoring and diagnostic:** Using the Machine Defender app, FALCON analyzer, the EAGLE or SPARROW wireless monitoring solution, or the MV-x real timemonitoring units
- **Open data platform:** Standard format publication allowing easy integration in your digital factory
- **Multitechnological integration:** Vibration, laser alignment reports and trends, thermographic pictures.

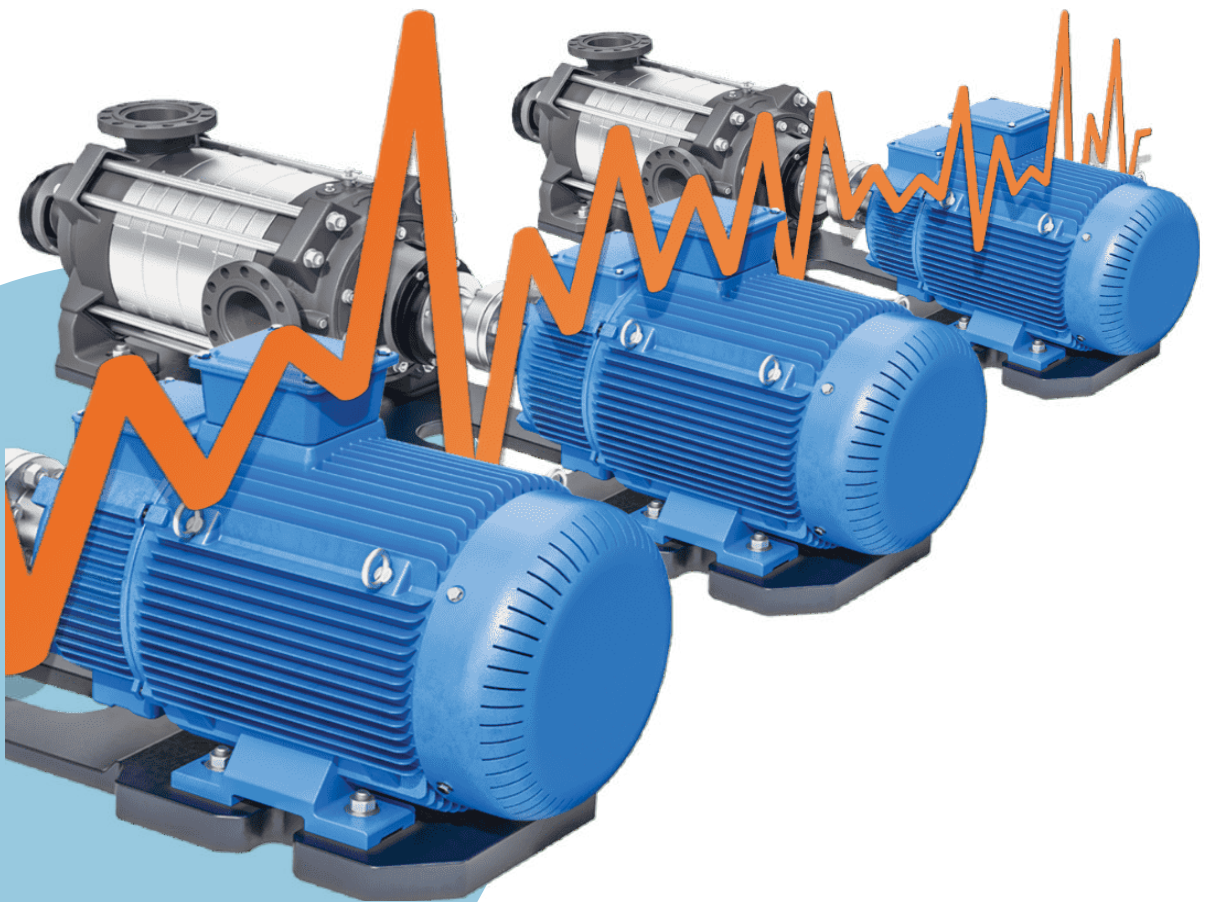

Machine Health Matrix

Fast, easy identification of the health of your machines.

- Analyze a machine's health on just one screen
- Overview of all parameters and easy drill-down to each individual parameter and point
- Manage and access data for even the largest machines
- Full reporting capability
- Add and customize parameters in no time
- Direct access to waveforms and spectra
- Easily locate and identify possible defects.



NEST i4.0 is powerful and productive tool to manage the predictive maintenance program

It can be managed even without specific vibration knowledge as it includes an automatic setup based on machine kinematic description.

In addition, ACOEM ACCUREX™ analysis method offers the possibility to get automatic diagnosis. For the vibration analyst, it is a way to save a lot of time as he/she can focus on machines which really needs to be looked at in details. This analysis is also speed up with dedicated functions:

The Health Matrix

SFx & HMx Indexes

Merged Spectrum

Shock Finder Filter

"With NESTi4.0 machine builder, it is possible to create a full reliable machine setup with a hundred of parameters in less than a minute, without any vibration expertise required"

Accurex™ Diagnostic Matrix

Machine diagnosis at a glance

Access machine diagnostics at a glance:

- Know what the defects are
- Know where the defects are located
- Know how important they are
- Know the confidence level.

Accurex™ Matrix available for any machine

- Smart display of the Accurex™ automatic diagnostic
- Smart display of the real expert diagnostic.

Running speed detection alerts

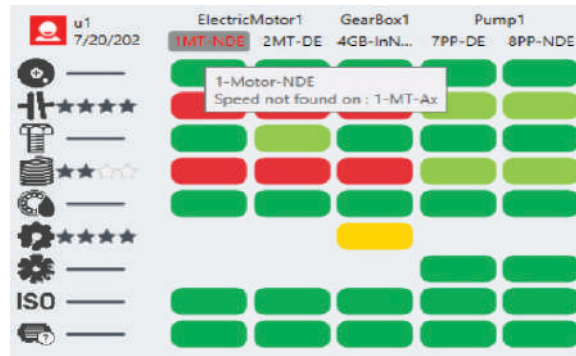

Enhanced reporting productivity

- Save up to 50% on reporting time
- Automatic text generation from the matrix
- Can be modified manually if needed
- Accurex™ Matrix included in report

Expert productivity boosted by Accurex AI

- Save additional time in your periodical analysis thanks to the automatic consideration of your previous diagnostic.

Intensify your efficiency!

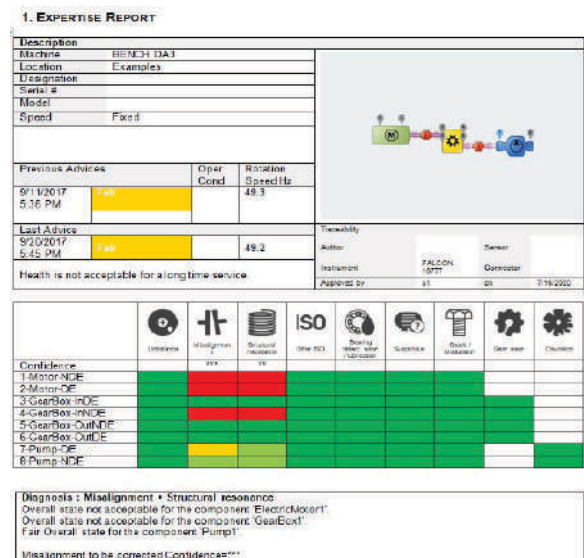
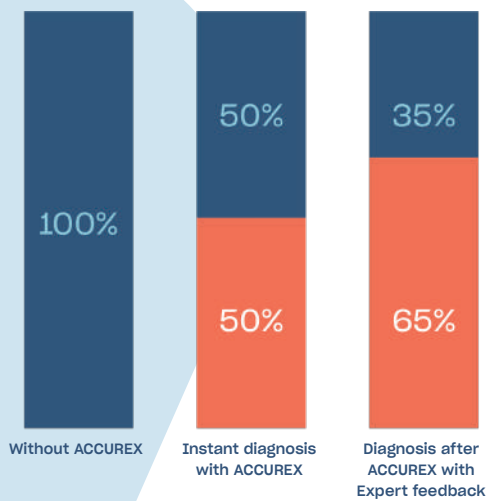

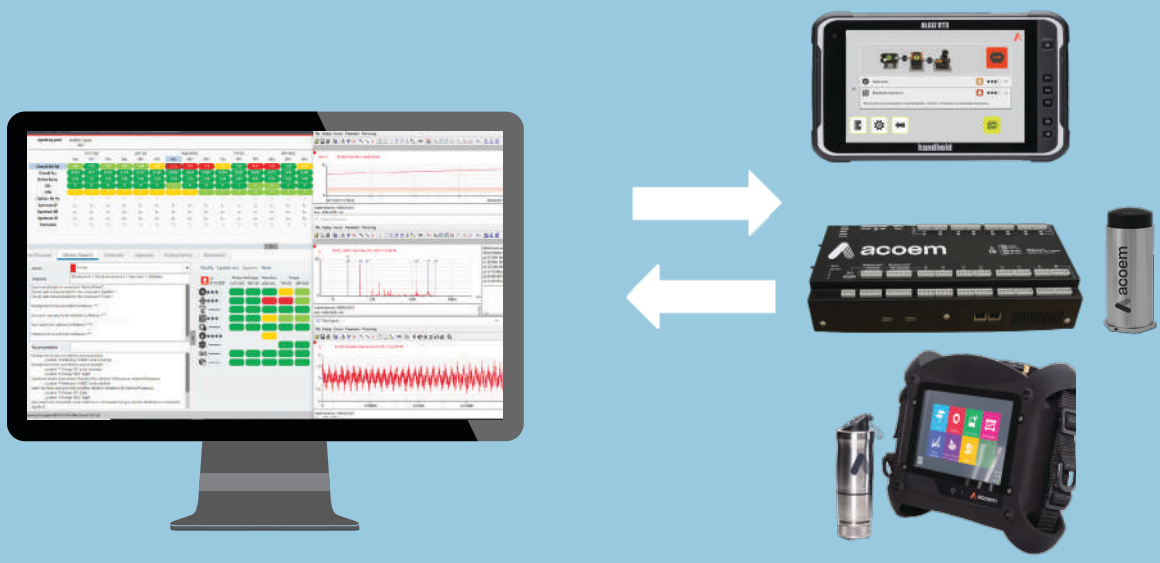

"Accurex™ Artificial Intelligence offers unrivalled instant automatic diagnostic capabilities. It is the result of the modelization of our 50+ years of experience through a Bayesian network, additionnally powered by machine learning on our long history of qualified diagnostics."

A secure solution, approved by customers of nuclear and military applications:

- SSL communication encryption
- LDAP user Authentification
- Communication with the software initiated by the IoT (Eagle, Sparrow, MVX)
- Data integrity and backup tools.

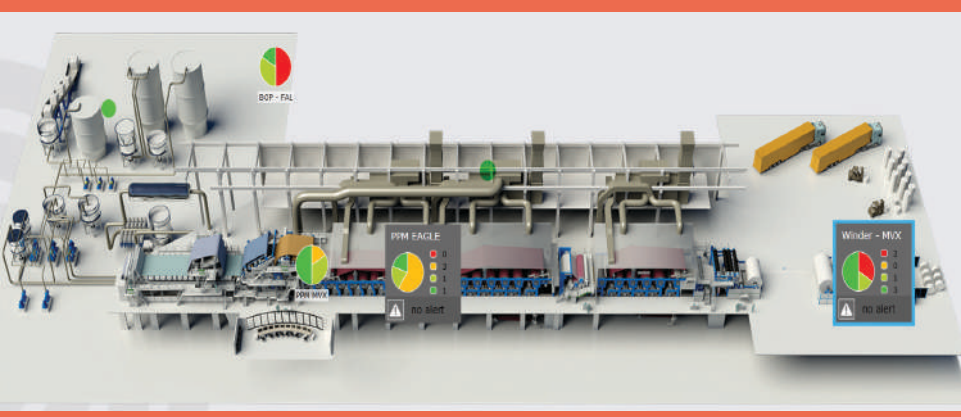

Easy Access To Big Data

NESTi4.0 Software provides exactly that, for everyone involved in maintaining industrial machinery in operational conditions.

Intuitive and resolutely visual, it makes the assets' health condition available to staff at all responsibility levels, regardless of prior expertise. Reports are instantly accessible from anywhere around the world, via an ordinary internet connection.

Machine Builder

Quick and intuitive set up: drag and drop

- Build complex machines with hundreds of vibration parameters in just minutes
- Create virtually any machine using built-in or customized templates
- Compatible with Accurex™ automatic diagnostics
- Accessible to all staff levels
- Build what you will see during the analysis
- Easily add or modify a parameter or signal on one of several measurement points at the same time
- Create custom complex machines with the use of the custom component
- Customizable: number of bearings, 1 or 2 shaft outputs, speed ratio for each shaft
- Free component labelling.

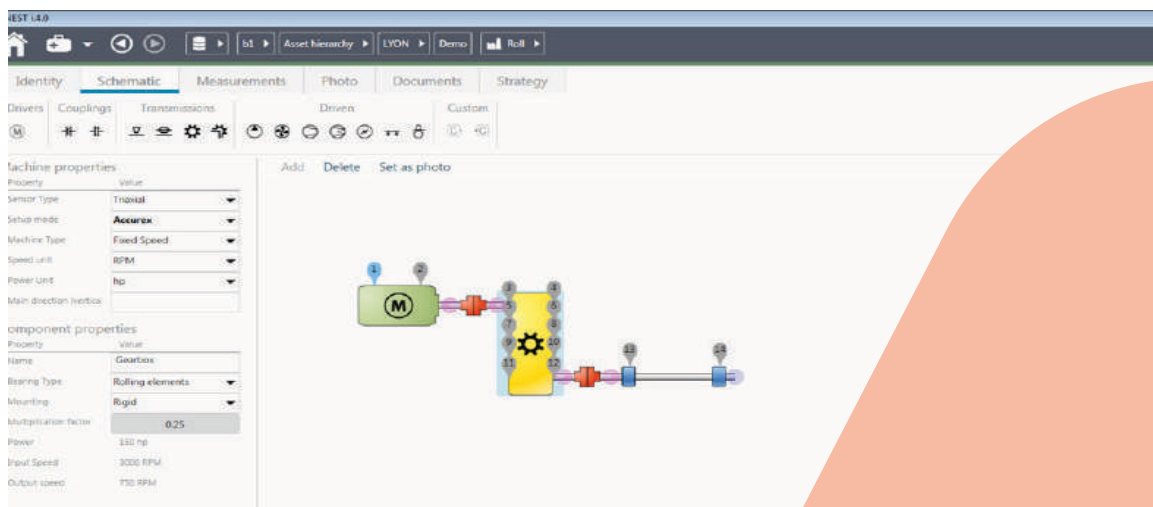
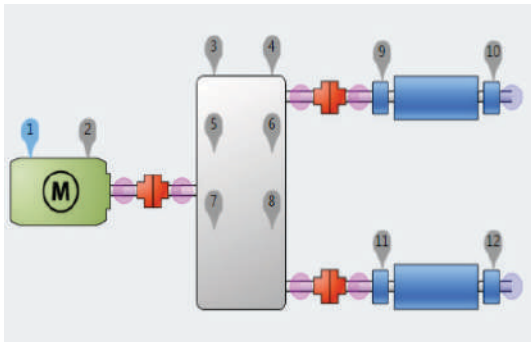

Nesti4.0 Webportal

The Next evolution of a powerful Reliability platform



The next generation Nesti4.0 webportal takes real time, remote monitoring of a fleet of assets to the next level. Ticking all the boxes it enables access to data coming from all acoem signature's devices, in a full web interface with responsive display available from any mobile device in the field.

The new WebPortal interface delivers all-in-one centralized view of multi sites health, greater access to all users, enables actionable data at a fingertip, highlights assets of interests and provides a highly flexible architecture (cloud or on premise).

Access machine diagnostic history in few clicks



Expand access to more users

- Providing the right level of information to the right people with user profile management
- Responsive display to best fit to mobile devices (smartphones, tablet)
- Native cloud technology, also deployable on premise



Accelerate reactivity



- Live alarm management from real time condition monitoring systems
- 24/7 access to live data trending coming from real time monitoring systems.

Streamline management & optimize maintenance

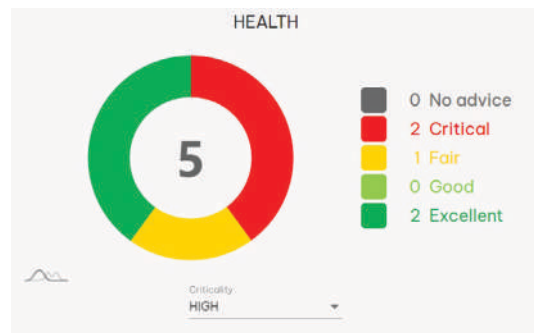

- Access to machine criticality information, allowing user to focus his attention on the machines which are the most critical to his process
- Instant link towards other systems such as CMMS, by sharing the Machine home page in a simple URL: no IT development required to easily connect systems access to the machine diagnostic history available in NESTi4.0

Centralise reliability analysis

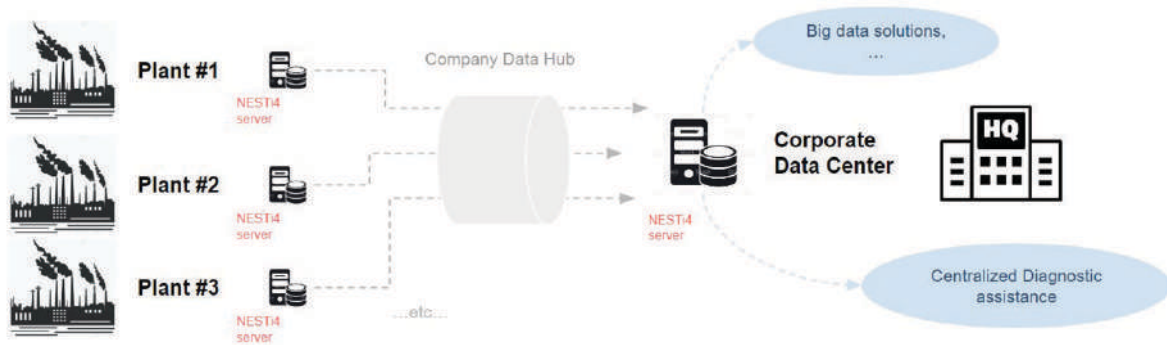

- Multisite overview thanks to new replication tool. Each local site can have independent local databases, that can be replicated to a centralised server.
- Here the web portal offers an holistic multi-site view of the health of a multisite company.





acoem
CREATING ENVIRONMENTS OF POSSIBILITY

Acoem India
Corporate Office:
Ground Floor, 1965,
Alembic City, Gorwa,
Vadodara, Gujarat - 390003
info.in@acoem.com | +91 265 6180 700
Vadodara | Indore | Delhi | Hyderabad | Kolkata
www.acoem.com

About Acoem

At Acoem, we create environments of possibility - helping organisations find the right balance between progress and preservation - safeguarding businesses and assets, and maximising opportunities while conserving the planet's resources. We deliver unrivalled, interoperable AI-powered sensors and ecosystems that empower our customers to make enlightened decisions based on accurate information.

Together with 220+ distribution partners, our 850+ employees work across 28 offices, 6 manufacturing facilities and 5 R&D centres in 11 countries, to provide trusted, holistic data solutions for customers worldwide.

For more information, please visit [acoem.com](https://www.acoem.com)